



Case Study

Jinko ESS Solution of Off-grid DC-coupled System

3.45MW-6.88MWh BESS and 5MWp PV Project in Saudi Arabia

Project Overview

Jinko has delivered a 3.45MW-6.88MWh battery energy storage system as well as 5MWp PV panels to one project in Saudi Arabia. The project aims to build a new residential community for the East-West Pipeline Pumping Station and Pressure Reduction Station in Saudi Arabia to replace the existing residential community located in a hazardous area.

The solution includes 2 units of Suntera 3.44MWh battery

containers, which features uniquely high energy density, and balanced cell temperature to deliver ultra-safety and long life contributed by its patent-designed stepping liquid cooling scheme. DC-DC converters are integrated with the PCS, resulting that all batteries can be charged from PV with an efficiency up to 99%.

PV+BESS solution works as main power source of the site

24hours one day and DGs will only be in operation when the SOC of battery reaches the lower limit, which minimizes the carbon emissions.

This initiative is presently the largest battery installed in Medina, Saudi Arabia, providing enough renewable power for 1,748 Saudi Aramco employees and contractors working at the pumping station every year.

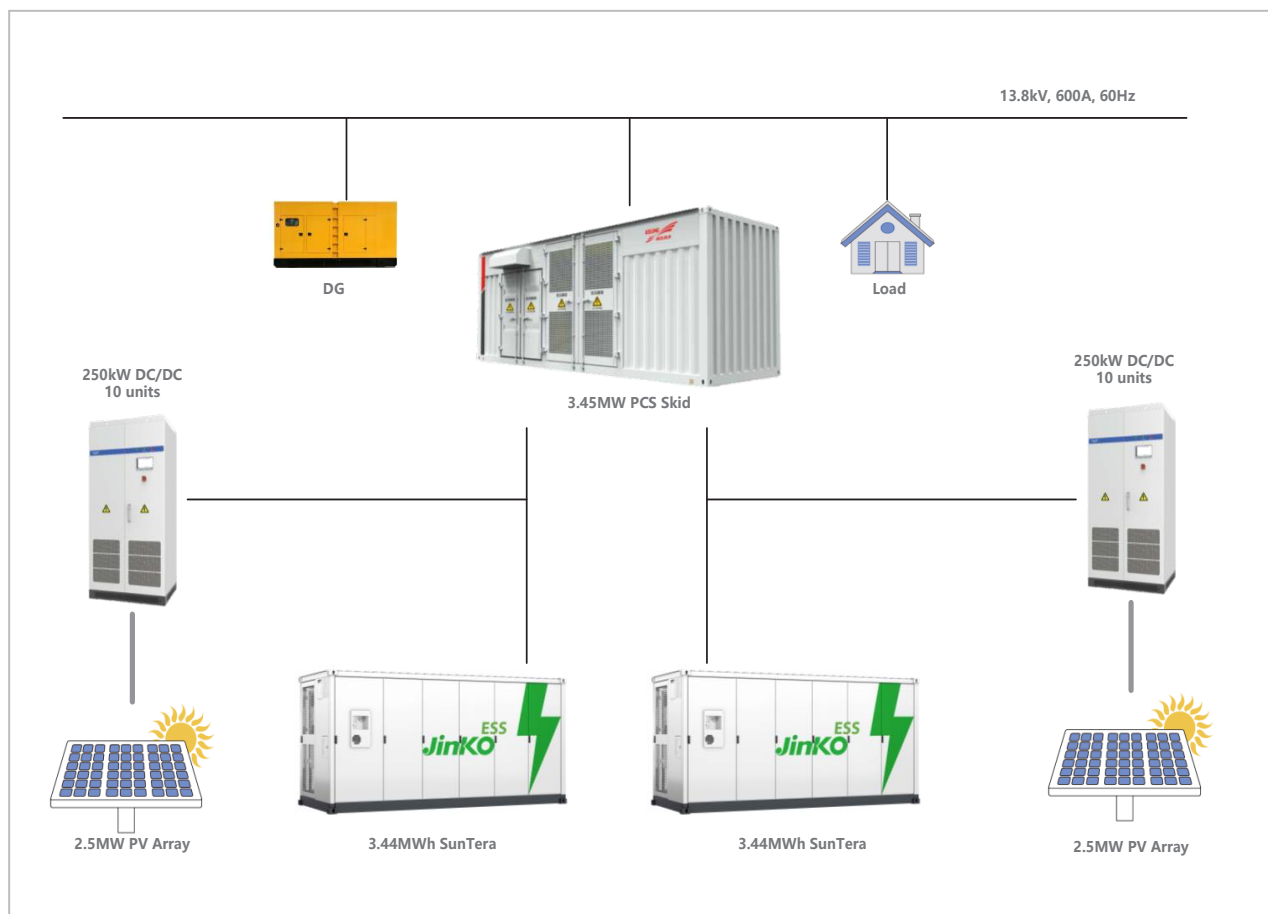

Fig. 1 Single Line Diagram of Off-grid DC Coupling System

The Solution

The above SLD indicates the overall system configuration of the site. 3 units of diesel generators each rated at 1286kW, BESS system and load outlet are connected together with the 13.8kV middle voltage busbar.

The rated power of the PCS-transformer station is 3.45MVA, which consists of 2 sets 1725kVa PCS, 1 set double split winding 13.8kV transformer and SF6 insulated switchgear. Two PCSs work together in VSG mode and maintain the stability of grid frequency and voltage.

The BESS system is integrated with a 5MWp of PV array, total 8840 pcs of 575Wp PV modules are installed. There are 20 units of 250kW DC-DC converters and every 10 units

are placed inside one 40ft container. Each DC-DC converter is connected with 17 strings of PV modules, each string contains 26 pcs of modules.

One Suntera 3.44MWh battery container is coupled with 10 units of DC-DC converter at the DC confluence box installed inside the DC-DC converter container, and they are connected with DC terminals of one 1725kVa PCS.

Communication Topology

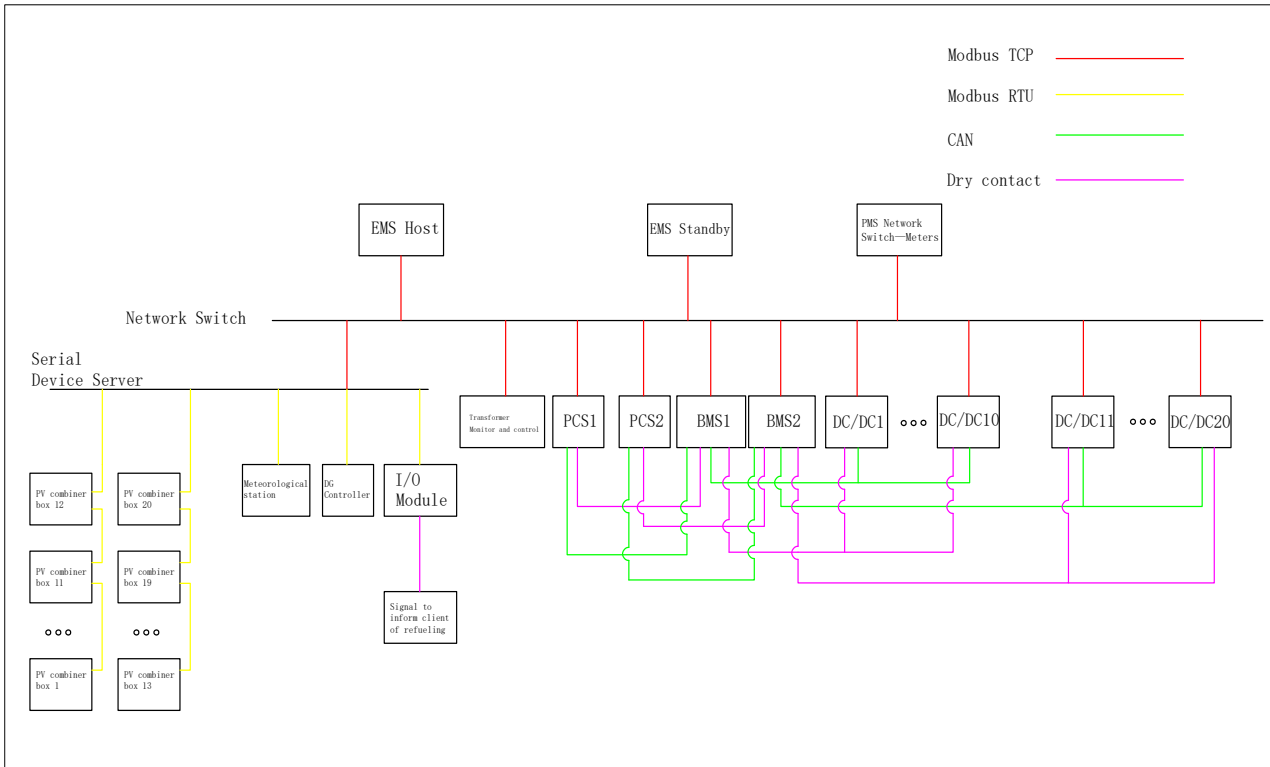

Fig. 2 Topological Graph of Off-grid DC Coupling System

The communication topology of the whole project is shown in above. PCS, Battery container, DC-DC converter and serial device server connect in network loop and communicate with EMS via Modbus/TCP.

BMS of battery container communicate with both the connected PCS and 10 sets of DC-DC converters, the communication protocol is CAN. And dry contacts are connected between BMS and PCS, BMS and DC-DC converters. They can shut down PCS and DC-DC converters in emergency conditions and avoid possible damage to batteries.

The serial device server can convert Modbus/TCP to Modbus/RTU, it communicates with PV combiner boxes, meteorological station and DG controller in this project.

EMS communicates with the PMS system installed in MV Switchgear Cabinet, and reads metering data of MV feeders like voltage, frequency and current.

The EMS is equipped with one main host and one standby host, the redundancy helps to achieve an availability higher than 99.9%.

Operation Logic

Day-ESS is charged from PV

PCS will be in VSG mode as a voltage source to stabilize the grid, while PV will run as current source, ESS will continue to be charged until full.

PV & ESS system in VSG mode can stabilize grid, battery can automatically absorb the excess PV power through DC bus. When PV voltage fluctuates, battery can stabilize the voltage of DC bus to maintain output of PV.

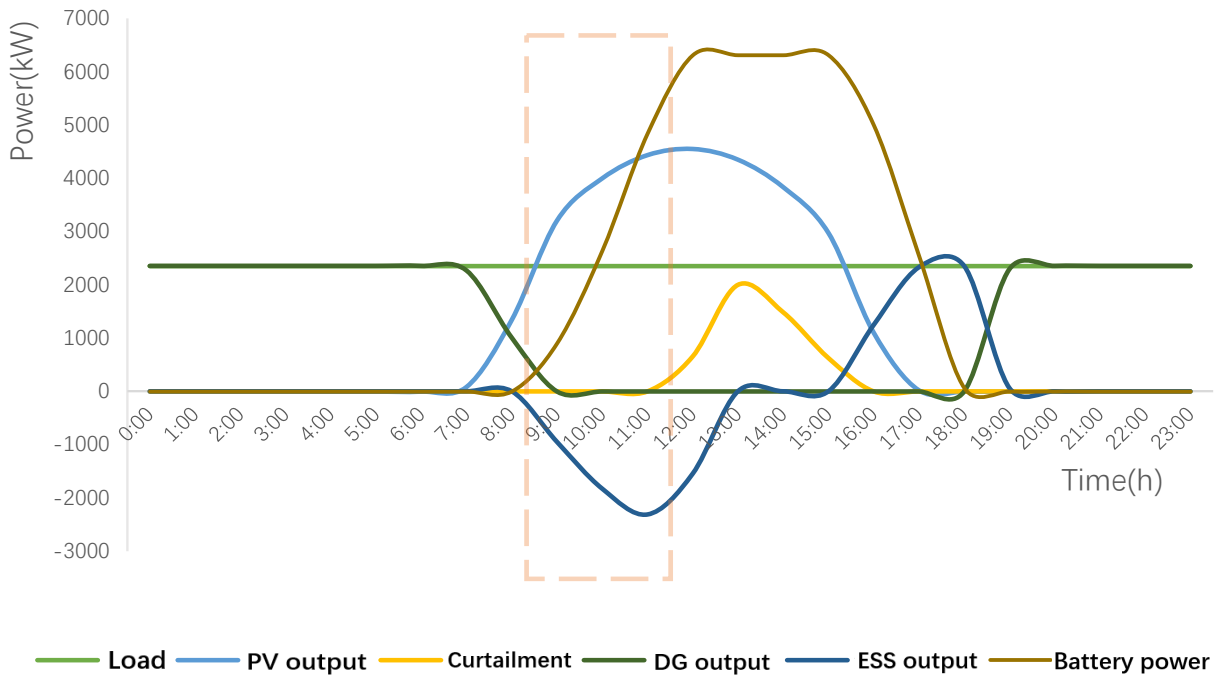

Fig. 3 Day-ESS is charged from PV

Day-ESS is full charged

PCS will be in VSG mode as a voltage source to stabilize the grid, while PV will run as current source. When ESS is full

charged, it will stop charging, while EMS will control power of PV DC converter to ensure ESS will not be overcharged.

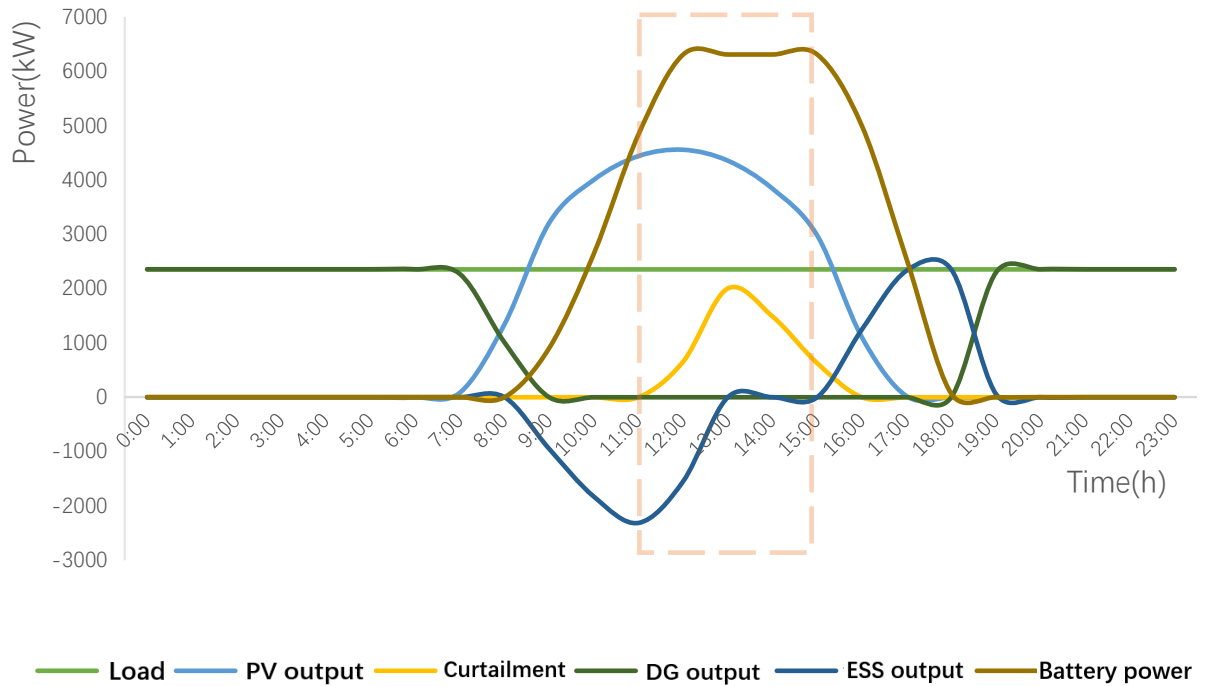

Fig. 4 Day-ESS is full charged

Night-ESS discharges-DG starts to run

PCS will be in VSG mode as a voltage source to stabilize the grid, while DG will start to run in VSG-PQ mode when power of ESS is low. With the detected load, EMS will control output of DG to be lower than total load, and ESS will provide the rest of the power. Or EMS will control DG running at high efficiency range to charge ESS, when power of ESS reaches high set level, DG will be shut down, only ESS runs for load. When power of ESS runs low, DG will be restarted.

Sunrise-power of ESS runs low-PV starts to run

PCS will be in VSG mode as a voltage source to stabilize the grid, while DG and PV will run as current source. With the increase output of PV, output of DG will gradually decrease until shut down.

Sunset-PV outputs-ESS starts to discharge

PCS will be in VSG mode as a voltage source to stabilize the grid, while PV will run as current source. When output of PV is less than the load, ESS will start to discharge.

Failure mode

When part of PV modules fails, such failure part will not affect the others and can be shut down, PV can run without such failure part. When part of ESS fails, it can reduce the output or shut down the PV & ESS system, while DG can be the main power supply. When 1 DG fails, the standby DG will start to run automatically.

Operating Records

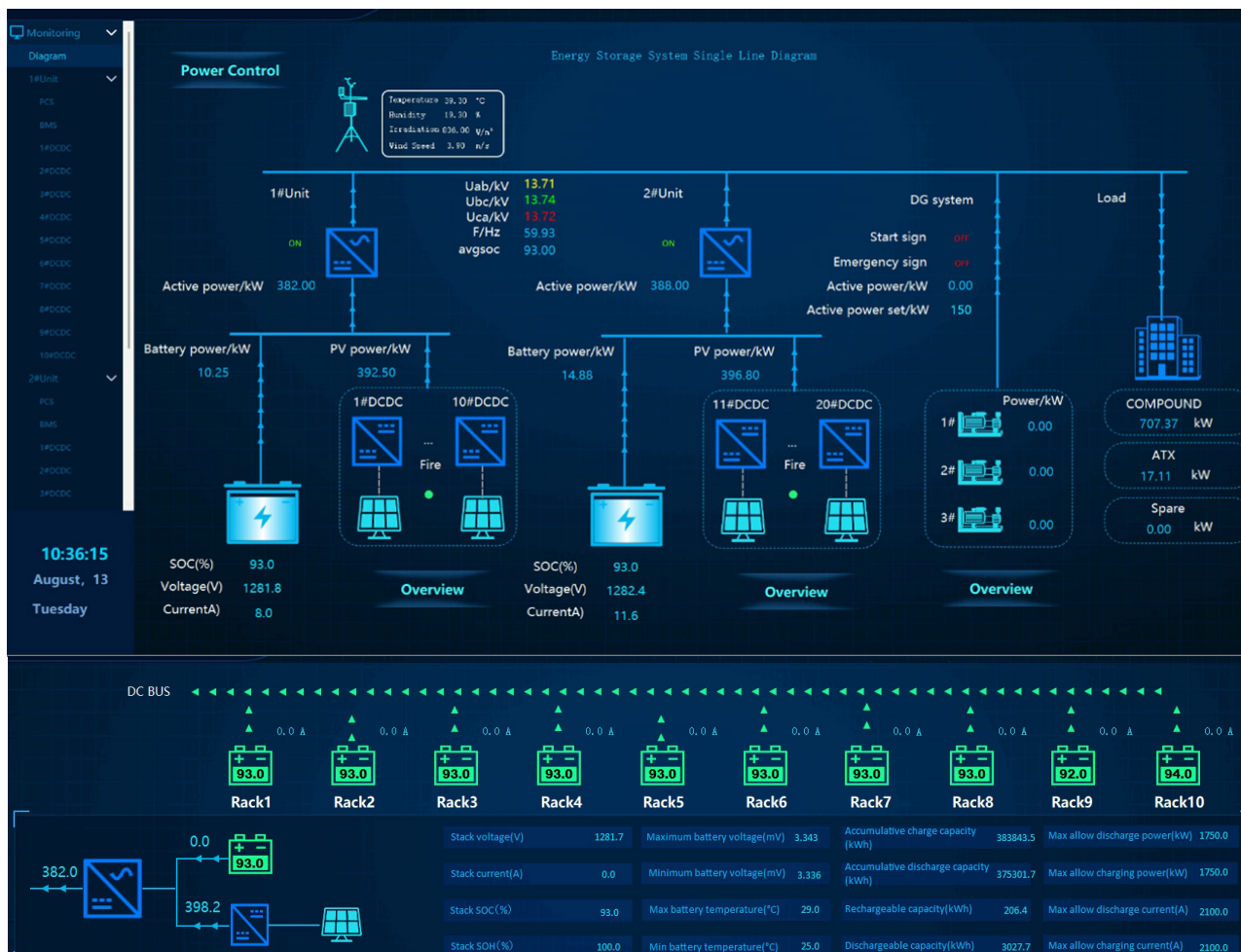

Fig. 5,6 The interface of EMS system

This project has kept working for several months and providing stable power supply to the site. The screen shot shows the main interface of our EMS system. It indicates the running status of the system after batteries are fully charged

in day time. The present battery SOC is 93%. The total load is 707.37kW, and all load are covered by PCS. 3 DGs are in standby. The total PV power is be limited to 789.3kW to avoid overcharging of batteries.

The cell parameters of one container are shown in above. The cell voltage difference is 0.007mV which indicates the good consistency of the cells. And it can be seen that

the maximum cell temperature is 29 °C and minimum cell temperature is 25 °C . The liquid cooling unit can control the cell temperature within proper range.

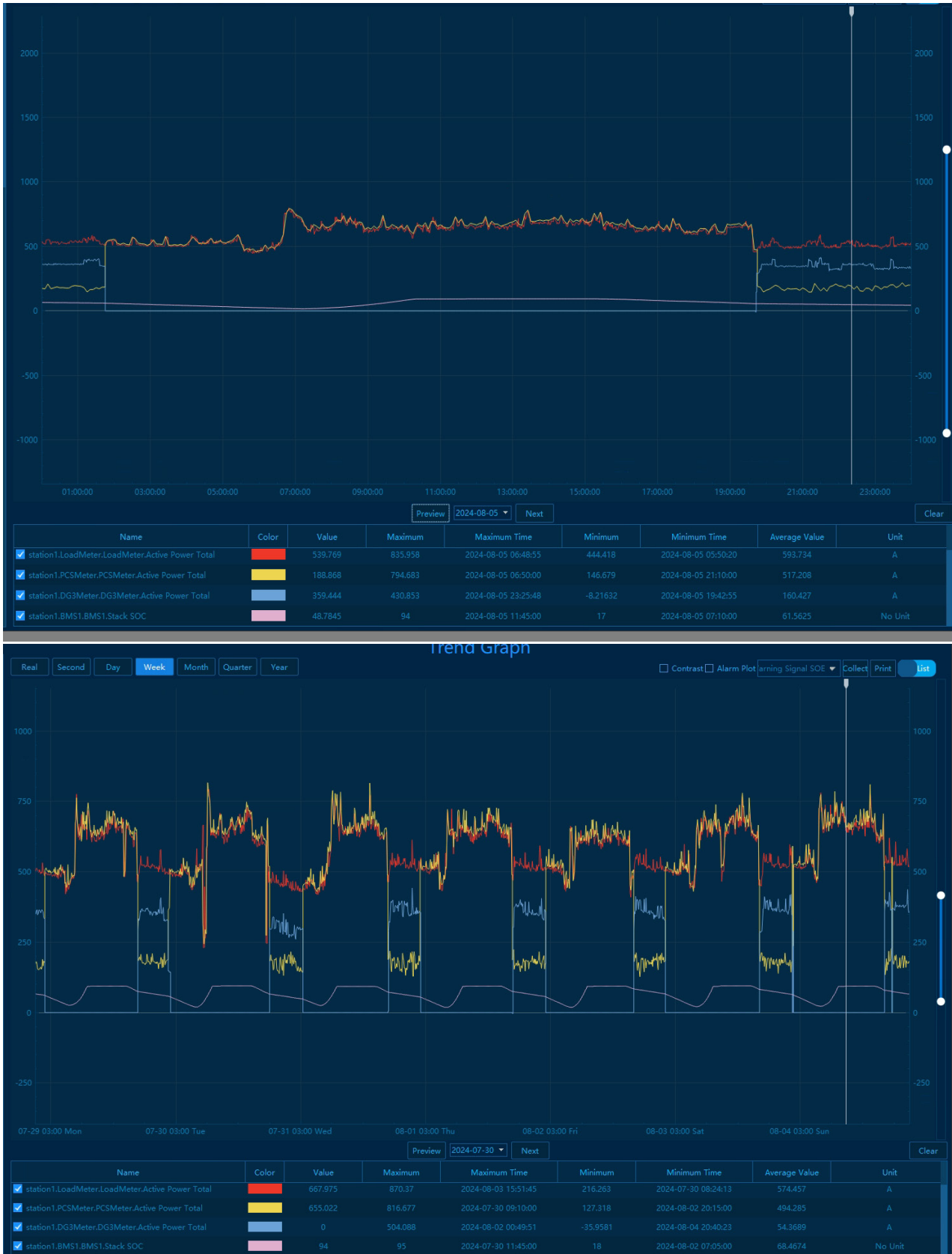

Fig. 7,8 The interface of EMS system

The power curves of the project in one day and in one week are shown in above. It can be found that the PV and PCS takes all load from 2:00am to 19:30pm every day. The DG shares the load with PCS at night from 19:30pm to 2:00am. During day time, PV charges the battery SoC to higher than

93%. During the nights, battery SoC discharges to reach around 18%. The curves show that Jinko Solar's middle voltage DC-coupled off-grid ESS solution guarantee a long-term stable power supply to client.

Key Features

Middle voltage level solution suitable for large scale loads

Equipped with step-up transformers, this solution is able to supply power at middle voltage which is suitable for loads up to tens of MWs. The middle voltage output helps to reduce the rated current of busbar and it can easily integrate with existing MV distribution network.

The load of this project is estimated to be around 2.4MW at design stage, the 3.45MVA PCS-transformer station owns enough capability to supply power to the whole site. The standard PCS-transformer station shares the same design with on-grid products, which guarantees a shorter delivery time than customized 400V output products.

For larger size of projects, the number of PCS-transformer station can be increased easily and all PCS-transformer station will be connected in series by CCV structure RMUs. This solution is especially suitable for application scenarios like mines, factories and large residential areas.

DC-coupled solution with higher efficiency and lower cost

Solar power is the main power source of this off-grid project,

Suntera battery container stores the excess PV power at day and supply power during night time. How to reduce the energy loss during the energy storage process is the key concern of design.

Equipped with 1500V DC-DC converter, 26 pcs PV modules are connected in one string in series. The high working voltage can reduce the cable loss, decrease the total number of strings and save the usage of cables.

For the DC-coupled solution, the PV directly charges Suntera battery container via DC-DC converter. Compared to a normal AC-coupled solution which needs another step-transformer for PV inverters, PV and BESS can share one transformer and one MV feeder in DC-coupled solution. It can help a lot to reduce the cost of project.

For a normal AC-coupled solution, considering the efficiency of PV inverter, PV step-up transformer, PCS step-up transformer and PCS, the charging efficiency shall be lower than 96%. However, the charging efficiency can be maximum 99% in this DC-coupled solution, considering that there is only one DC-DC converter between PV modules and batteries.

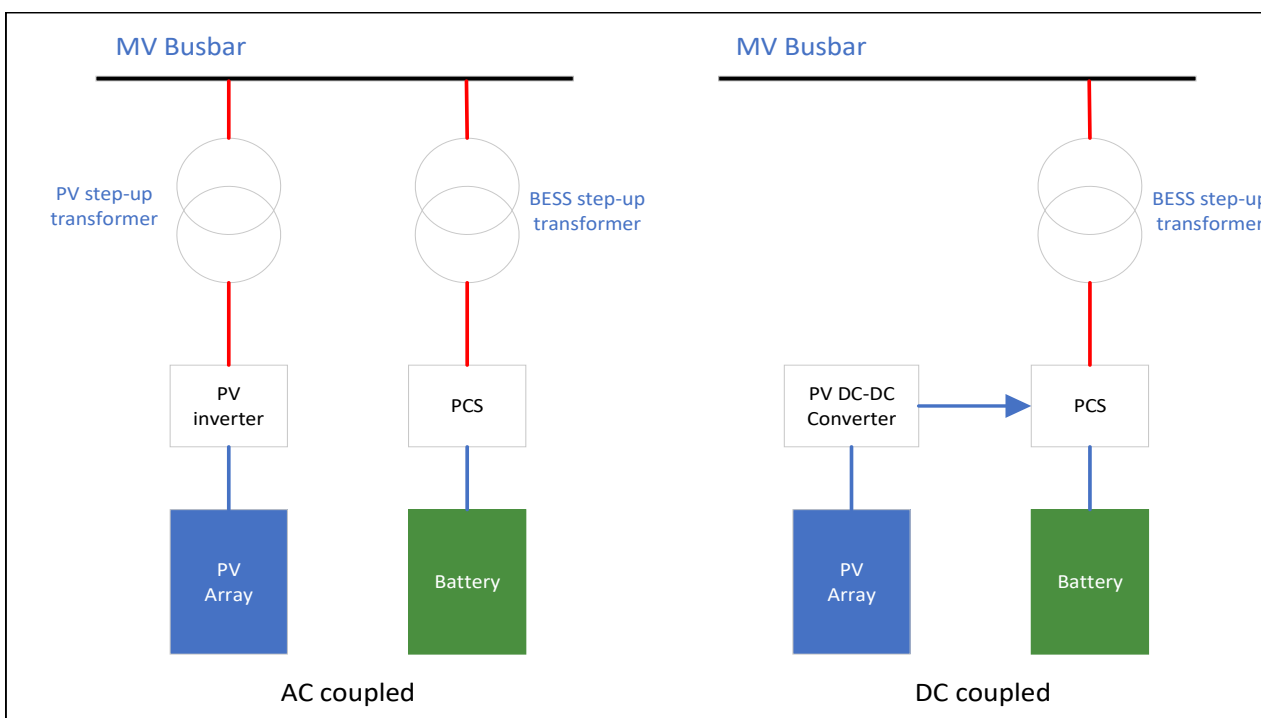

Fig. 9 AC-coupled vs. DC coupled

Seamless switching between DG and BESS

Based on VSG working mode of PCS, the seamless connecting and disconnecting of DG can be achieved in MV system. The 2 sets of 1725kVa PCS keep working as the main power source, and DG will connect with the system when the SOC of battery reaches lower limit during nights. After the morning when PV power is larger enough to handle the load, DG will be shut down and disconnect from the system.

The EMS can work together with the DG controller and sets the running output power of DGs in VSG-PQ mode. When the DGs are working together with PCS, DG power is controlled by EMS to be a relatively stable to balance the load and PCS will cover all the instant fluctuations of frequency and voltage.

With this seamless switching function, no outage will happen during the operation of PV+BESS+DG system.

Hot and sandy conditions

The project locates at one desert area in Saudi Arabia, the maximum temperature in Summer is around 50 C . And it's very windy and dusty in some season.

The high efficiency liquid cooling unit of Suntera helps to keep a stable running of the whole BESS system in sandy and hot conditions. The liquid cooling unit can control the temperature of cells to be lower than 35 C and temperature difference to be lower than 5 C in all operation conditions.

Special designed sand proof air inlets help to prevent sand from influencing daily running of the battery container.



Fig. 10 The environment of Saudi Arabia

* The report serves as a general overview and is subject to updates by Jinko ESS. Jinko ESS reserves the right to modify the content and holds the final authority in its interpretation.



Jinko Solar Co.,Ltd.

No.1, Lane 1466, Shenchang Road,Minhang

District, Shanghai, China

Tel +86 400 860 8878

Case Study

Jinko ESS Solution of Off-grid DC-coupled System